

## PW3134K

### 20V N-Channel MOSFET

0.75A 20V;  $R_{DS(ON)typ}=190m\Omega@4.5V$ ,  $R_{DS(ON)typ}=260m\Omega@2.5V$ ,  
 $R_{DS(ON)typ}=390m\Omega@1.8V$

#### FEATURE

- Lead Free Product is Acquired
- Surface Mount Package
- N-Channel Switch with Low  $R_{DS(on)}$
- Operated at Low Logic Level Gate Drive

#### Application

- Load/Power Switching
- Interfacing Switching
- Battery Management for Ultra Small Portable Electronics
- Logic Level Shift

#### MARKING:

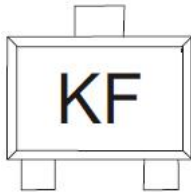

#### SOT-723

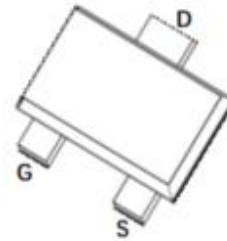

#### Schematic diagram

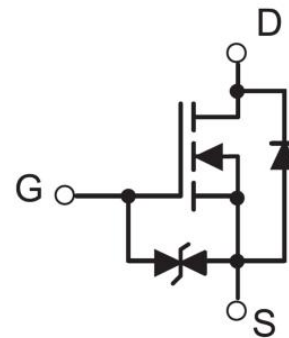

#### ABSOLUTE MAXIMUM RATINGS ( $T_a=25^\circ\text{C}$ unless otherwise noted)

Parameter	Symbol	Value	Unit
Drain-Source Voltage	$V_{DS}$	20	V
Gate-Source Voltage	$V_{GS}$	$\pm 12$	V
Continuous Drain Current <sup>(1)</sup>	$I_D$	0.75	A
Pulsed Drain Current( $t_p=10\mu\text{s}$ )	$I_{DM}$	1.8	A
Power Dissipation <sup>(1)</sup>	$P_D$	150	mW
Thermal Resistance from Junction to Ambient <sup>(1)</sup>	$R_{\theta JA}$	833	$^\circ\text{C/W}$
Junction Temperature	$T_J$	150	$^\circ\text{C}$
Storage Temperature	$T_{STG}$	-55~ +150	$^\circ\text{C}$
Lead Temperature for Soldering Purposes(1/8" from case for 10s)	$T_L$	260	$^\circ\text{C}$

**MOSFET ELECTRICAL CHARACTERISTICS(T<sub>a</sub>=25°C unless otherwise noted)**

Parameter	Symbol	Test Condition	Min	Type	Max	Unit
<b>STATIC CHARACTERISTICS</b>						
Drain-source breakdown voltage	V <sub>(BR)DSS</sub>	V <sub>GS</sub> = 0V, I <sub>D</sub> =250μA	20			V
Zero gate voltage drain current	I <sub>DSS</sub>	V <sub>DS</sub> =20V, V <sub>GS</sub> = 0V			1	μA
Gate-body leakage current	I <sub>GSS</sub>	V <sub>GS</sub> =±10V, V <sub>DS</sub> = 0V			±20	μA
Gate threshold voltage <sup>(2)</sup>	V <sub>GS(th)</sub>	V <sub>DS</sub> =V <sub>GS</sub> , I <sub>D</sub> =250μA	0.35	0.75	1.1	V
Drain-source on-resistance <sup>(2)</sup>	R <sub>DS(on)</sub>	V <sub>GS</sub> =4.5V, I <sub>D</sub> =650mA		190	260	mΩ
		V <sub>GS</sub> =2.5V, I <sub>D</sub> =550mA		260	360	
		V <sub>GS</sub> =1.8V, I <sub>D</sub> =450mA		390	590	
Forward tranconductance	g <sub>FS</sub>	V <sub>DS</sub> =10V, I <sub>D</sub> =800mA		1.6		S
<b>DYNAMIC CHARACTERISTICS<sup>(4)</sup></b>						
Input Capacitance	C <sub>iss</sub>	V <sub>DS</sub> =16V, V <sub>GS</sub> =0V, f=1MHz		79	120	pF
Output Capacitance	C <sub>oss</sub>			13	20	
Reverse Transfer Capacitance	C <sub>rss</sub>			9	15	
<b>SWITCHING CHARACTERISTICS<sup>(4)</sup></b>						
Turn-on delay time <sup>(3)</sup>	t <sub>d(on)</sub>	V <sub>DS</sub> =10V, I <sub>D</sub> =500mA, V <sub>GS</sub> =4.5V, R <sub>G</sub> =10Ω		6.7		ns
Turn-on rise time <sup>(3)</sup>	t <sub>r</sub>			4.8		
Turn-off delay time <sup>(3)</sup>	t <sub>d(off)</sub>			17.3		
Turn-off fall time <sup>(3)</sup>	t <sub>f</sub>			7.4		
<b>SOURCE-DRAIN DIODE CHARACTERISTICS</b>						
Diode Forward voltage <sup>(3)</sup>	V <sub>DS</sub>	I <sub>S</sub> =0.15A, V <sub>GS</sub> = 0V			1.2	V

**Notes:**

1. Surface mounted on FR4 board using the minimum recommended pad size.
2. Pulse Test : Pulse Width=300μs, Duty Cycle=2%.
3. Switching characteristics are independent of operating junction temperatures.
4. Guaranteed by design, not subject to producing.

**Typical Electrical and Thermal Characteristics**

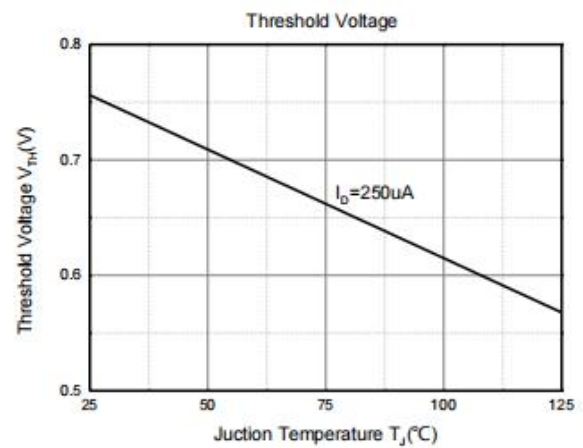
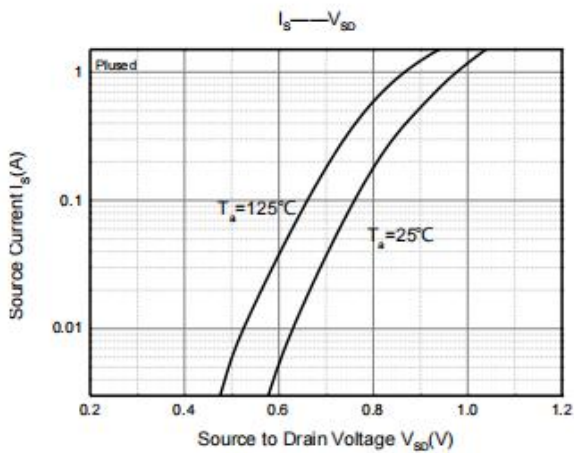
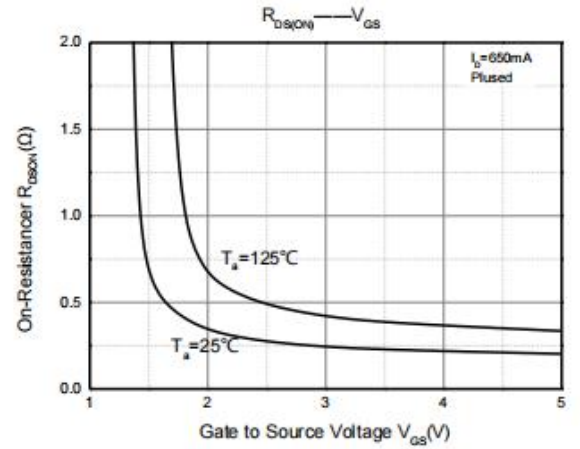
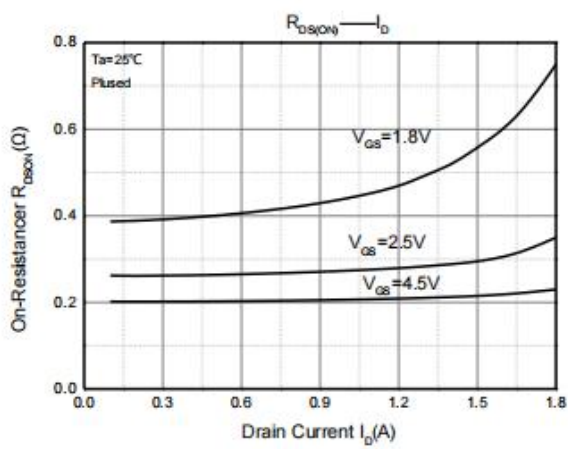
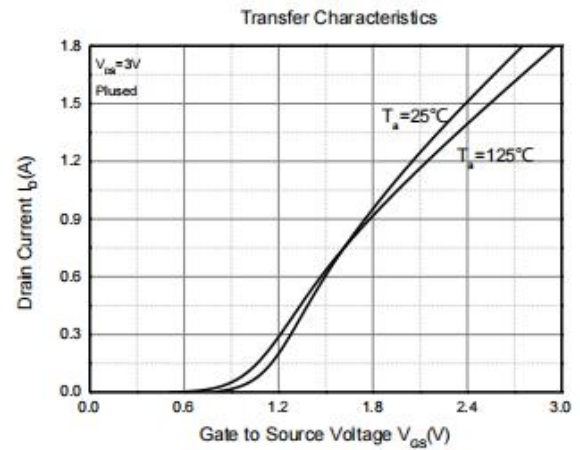
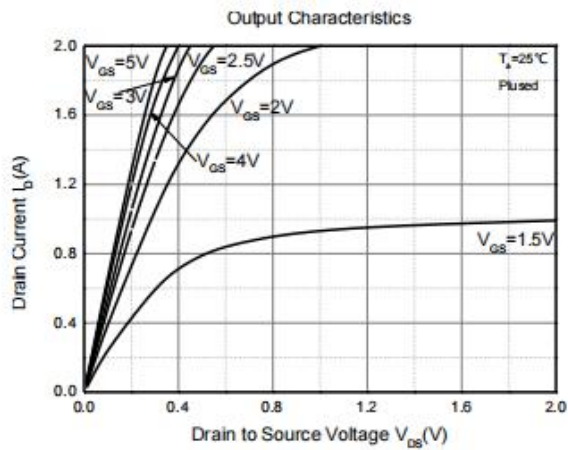

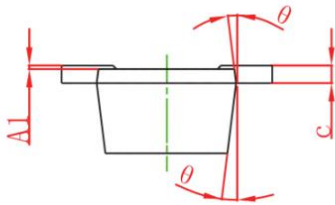
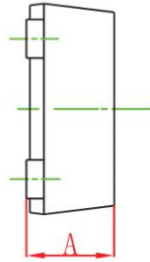
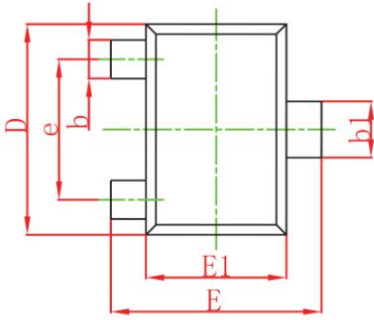

Symbol	Dimensions In Millimeters		Dimensions In Inches	
	Min.	Max.	Min.	Max.
A	0.430	0.500	0.017	0.020
A1	0.000	0.050	0.000	0.002
b	0.170	0.270	0.007	0.011
b1	0.270	0.370	0.011	0.015
c	0.080	0.150	0.003	0.006
D	1.150	1.250	0.045	0.049
E	1.150	1.250	0.045	0.049
E1	0.750	0.850	0.030	0.033
e	0.800TYP.		0.031TYP.	
$\theta$	7° REF.		7° REF.	

### SOT-723 Embossed Carrier Tape

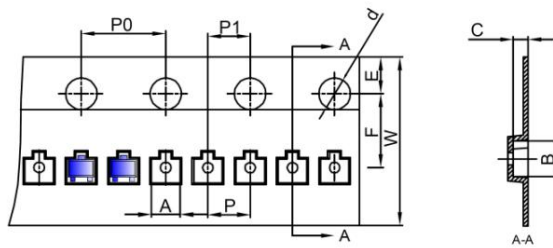

Dimensions are in millimeter										
Pkg type	A	B	C	d	E	F	P0	P	P1	W
SOT-723	1.33	1.45	0.61	Ø1.50	1.75	3.50	4.00	2.00	2.00	8.00

### SOT-723 Tape Leader and Trailer

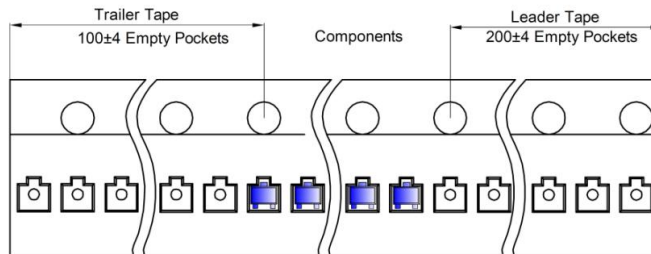

### SOT-723 Reel

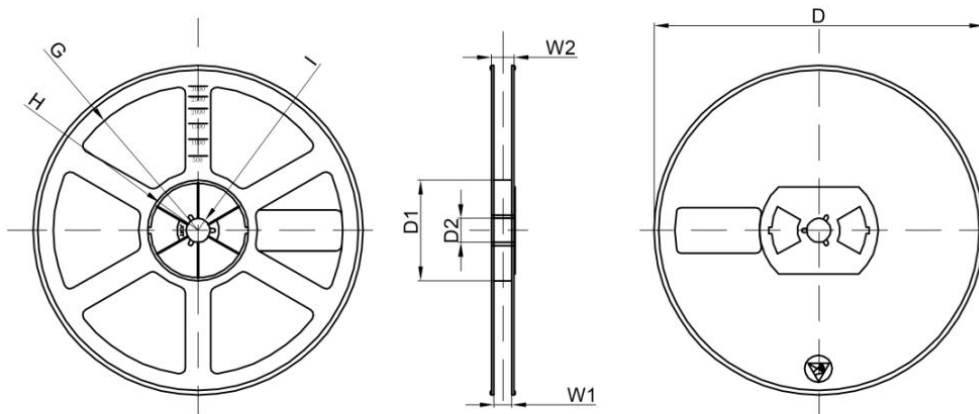

Dimensions are in millimeter								
Reel Option	D	D1	D2	G	H	I	W1	W2
7" Dia	Ø178.00	54.40	13.00	R78.00	R25.60	R6.50	9.50	12.30

REEL	Reel Size	Box	Box Size(mm)	Carton	Carton Size(mm)	G.W.(kg)
8000 pcs	7 inch	80,000 pcs	203×203×195	320,000 pcs	438×438×220	