

MBR20200BCT&MBR20200HCT

20.0AMPS. SCHOTTKY BARRIER RECTIFIERS

FEATURE

- . High current capability
- . Low forward voltage drop
- . Low power loss, high efficiency
- . High surge capability
- . High temperature soldering guaranteed
260°C /10seconds, 0.25"(6.35mm)from case.

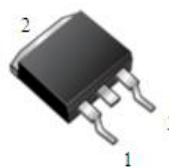

TO-263-2L
MBR20200BCT



TO-262-3L
MBR20200HCT

MECHANICAL DATA

- . Case: Molded with UL-94 Class V-0 recognized
Flame Retardant Epoxy
- . Mounting position: any

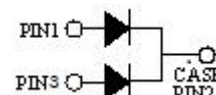

Single phase, half wave, 60Hz,resistive or inductive load.

For capacitive load, derate current by 20%

MAXIMUM RATINGS (T_C=25°C unless otherwise noted)

Parameter	Symbol	MBR20200BCT&MBR20200HCT	Units
Maximum Recurrent Peak Reverse Voltage	V _{RRM}	200	V
Maximum RMS Voltage	V _{RMS}	140	V
Maximum DC blocking Voltage	V _{DC}	200	V
Maximum Average Forward Rectified Current at T _C =100°C <i>Per Leg</i> <i>Total device</i>	I _{F(AV)}	10.0 20.0	A
Peak Forward Surge Current 8.3ms single half sine-wave superimposed on rated load (JEDEC method) <i>Per Leg</i>	I _{FSM}	150.0	A
Typical Junction Capacitance (Note 1)	C _J	140	pF
Operation Junction Temperature and Storage Temperature	T _J , T _{STG}	-55 to +150	°C

ELECTRICAL CHARACTERISTICS-(per leg) (T_A=25°C unless otherwise noted)

Parameter	Symbol	Test conditions	Typ	Max	Units	
Forward voltage drop	V _F	T _J =25°C	I _F =3A	0.73	---	V
			I _F =5A	0.77	---	
			I _F =10A	0.82	0.90	
		T _J =125°C	I _F =3A	0.56	---	
			I _F =5A	0.61	---	
			I _F =10A	0.68	0.76	
Reverse leakage current	I _R	T _J =25°C	V _R =200V	---	50	μA
		T _J =125°C	V _R =200V	---	10	mA

THERMAL CHARACTERISTICS(T_C=25°C unless otherwise noted)

Parameter	Symbol	MBR20200BCT	MBR20200HCT	Units
Typical Thermal Resistance (Note 2)	R _(JC)	2.0	2.0	°C/W

Notes:

1. Measured at 1.0 MHz and applied reverse voltage of 4.0Vdc
2. Thermal Resistance from Junction to Case

RATING AND CHARACTERISTIC CURVES

FIG.1-TYPICAL FORWARD CURRENT DERATING CURVE

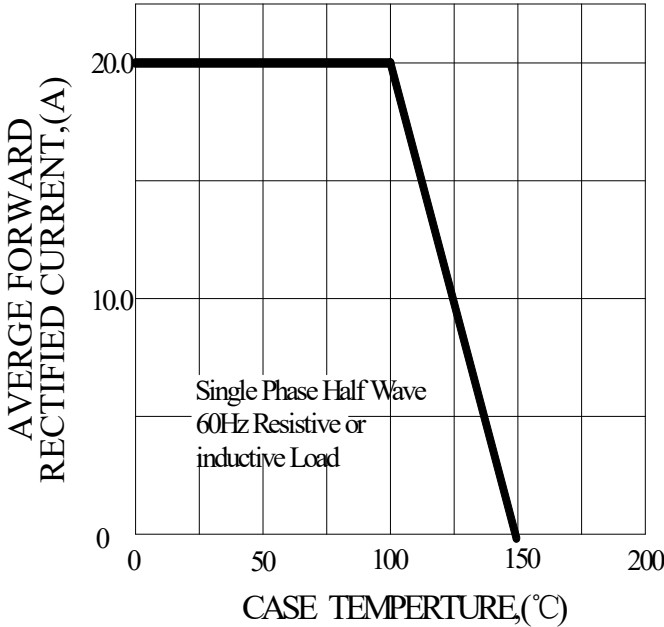

FIG.2-TYPICAL INSTANTANEOUS FORWARD CHARACTERISTICS

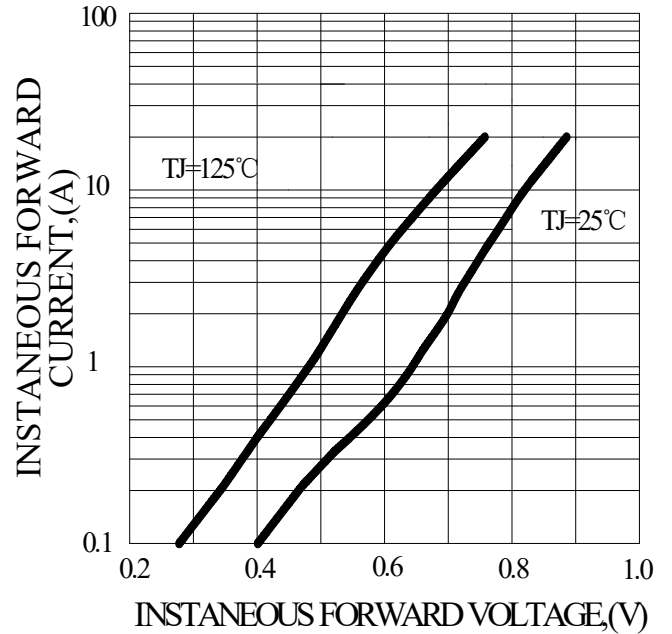

FIG.3-MAXIMUM NON-REPETITIVE FORWARD SURGE CURRENT

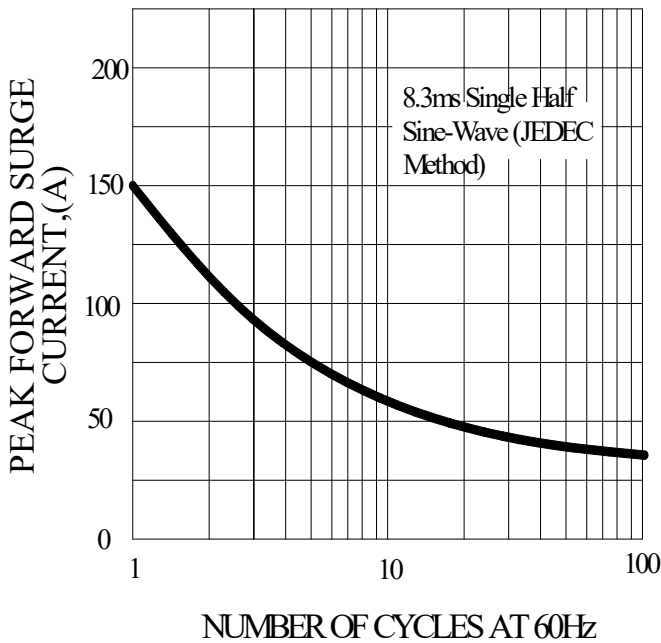
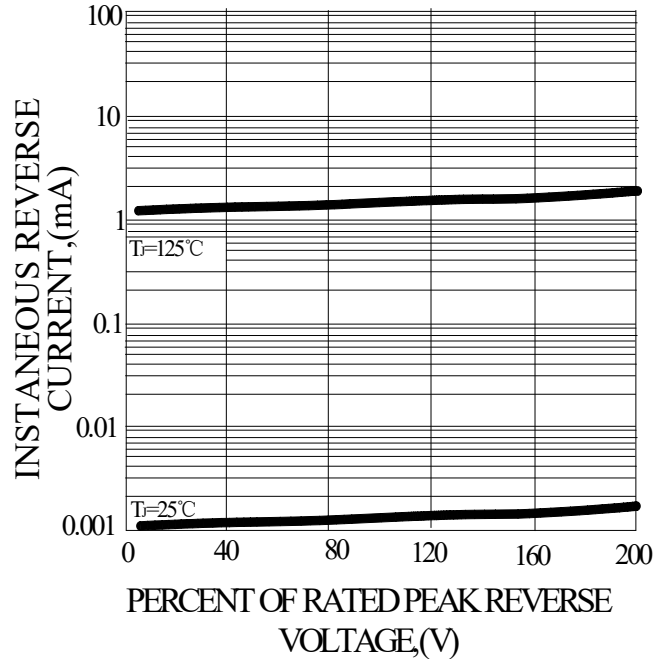
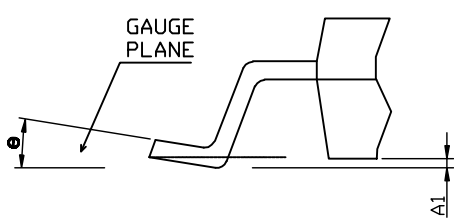
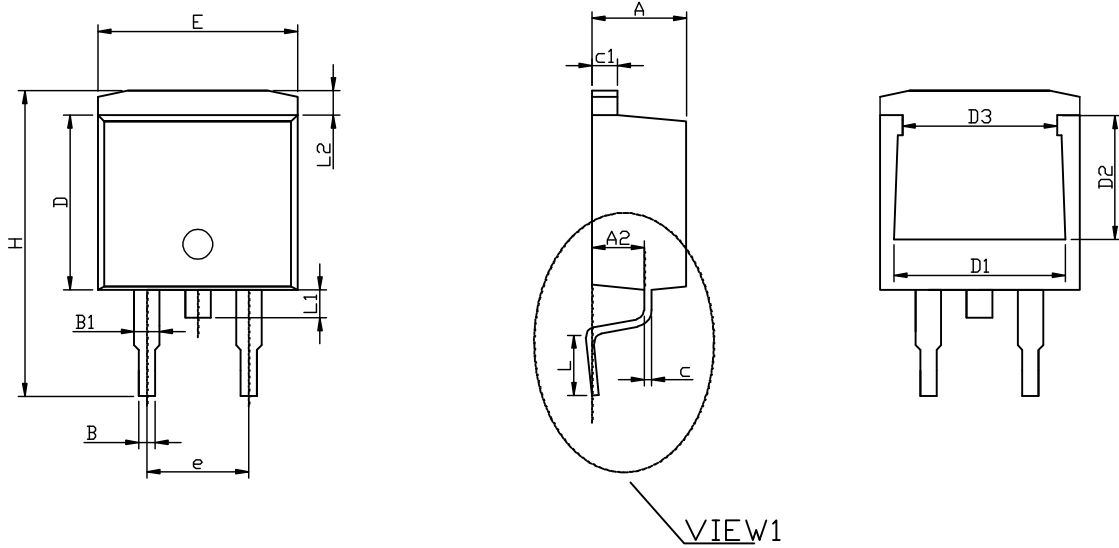

FIG.4-TYPICAL REVERSE CHARACTERISTICS



TO-263-2L PACKAGE OUTLINE



VIEW1

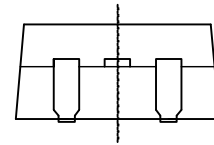

RECOMMENDED LAND PATTERN

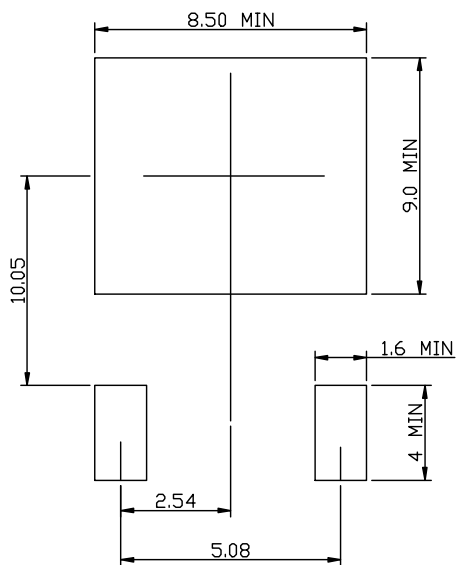

	MIN	NOM	MAX
A	4.50	4.70	4.90
A1	0.05	0.15	0.30
A2	2.45	2.60	2.70
B	0.72	0.82	0.92
B1	1.12	1.27	1.42
c	0.28	0.38	0.48
c1	1.17	1.27	1.37
D	8.46	8.66	8.86
D1	7.90	8.10	8.40
D2	5.50	5.70	5.90
D3	7.10	7.30	7.50
E	9.85	10.15	10.45
e		5.08BCS	
H	14.75	15.15	15.55
L	2.30	2.55	2.80
L1	1.20	1.40	1.60
L2	1.01	1.23	1.50
θ	0°	7°	8°

UNIT: mm

TO-262-3L PACKAGE OUTLINE



RECOMMENDED LAND PATTERN

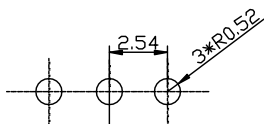

UNIT: mm

	MIN	NOM	MAX
A	4.50	4.70	4.90
A1	2.45	2.60	2.70
B	0.72	0.82	0.92
B1	1.12	1.27	1.42
c	0.28	0.38	0.48
c1	1.17	1.27	1.37
D	8.46	8.66	8.86
D1	7.90	8.10	8.40
D2	5.50	5.70	5.90
D3	7.10	7.30	7.50
E	9.85	10.15	10.45
e		2.54	
H	23.20	23.60	24.00
L	13.10	13.60	14.10
L1	3.85	4.05	4.35
L2	1.01	1.23	1.50