

GBU1506 THRU GBU1510

SINGLE PHASE 15.0AMPS.GLASS PASSIVATED BRIDGE RECTIFIERS

FEATURE

- . UL Listed Under Recognized Component Index, File Number E338195
- . High case dielectric strength
- . Low Reverse Leakage Current
- . High surge current capability
- . Ideal for Printed Circuit Board Applications

MECHANICAL DATA

- . Case Material: Molded Plastic.
- . UL Flammability Classification Rating 94V-0
- . Terminals: Pure tin plated, Lead free.
- . Leads solderable per MIL-STD-750, Method 2026.
- . Polarity: Molded on Body
- . Mounting: Through Hole for #6 Screw
- . Mounting Torque: 5.0 in-lbs Maximum
- . RoHS 2.0 Compliant
- . Halogen free

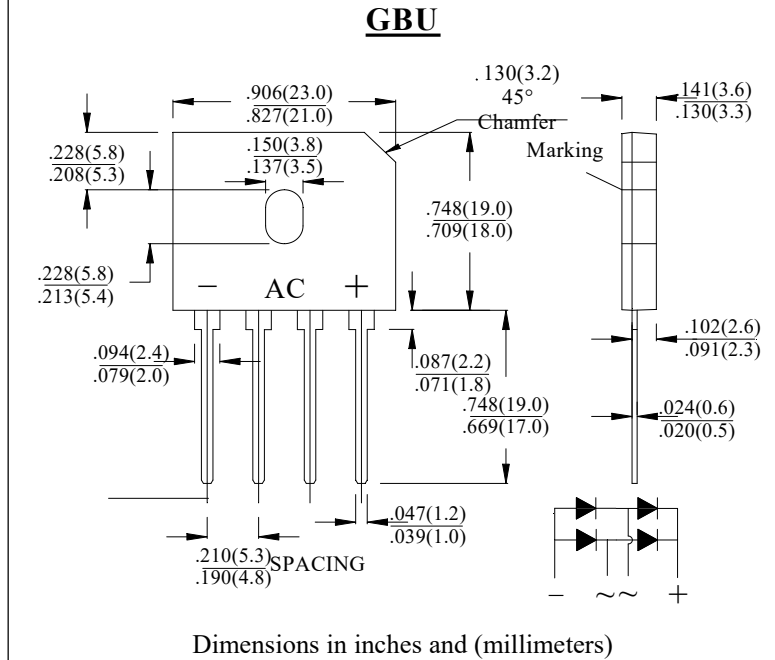

MAXIMUM RATINGS AND ELECTRICAL CHARACTERISTICS

Ratings at 25°C ambient temperature unless otherwise specified.

Single phase, half wave, 60Hz, resistive or inductive load. For capacitive load, derate current by 20%

Type Number	SYM BOL	GBU1506	GBU1508	GBU1510	units
Maximum Recurrent Peak Reverse Voltage	V_{RRM}	600	800	1000	V
Maximum RMS Voltage	V_{RMS}	420	560	700	V
Maximum DC blocking Voltage	V_{DC}	600	800	1000	V
Maximum Average Forward (with heatsink Note2) Rectified Current @ $T_C=100^{\circ}C$ (without heatsink)	$I_{F(AV)}$		15.0 3.2		A
Peak Forward Surge Current 8.3ms single half sine-wave superimposed on rate load (JEDEC method)	I_{FSM}		240		A
Maximum Forward Voltage @15A DC Drop per element @7.5A DC	V_F		1.1 1.05		V
Maximum DC Reverse Current @ $T_J=25^{\circ}C$ at rated DC blocking voltage @ $T_J=125^{\circ}C$	I_R		5.0 500.0		μA
I^2t Rating for Fusing ($t < 8.3ms$)	I^2t		239		A ² Sec
Typical Junction Capacitance (Note 1)	C_J		80		pF
Typical Thermal Resistance (Note 2)	$R_{(JA)}$		22		$^{\circ}C/W$
	$R_{(JC)}$		2.2		
Storage Temperature	T_{STG}		-55 to +150		$^{\circ}C$
Operating Junction Temperature	T_J		-55 to +150		$^{\circ}C$

Note:1. Measured at 1.0 MHz and applied reverse voltage of 4.0Vdc

2.Device mounted on 150mm x 150mm x 1.6mm Cu Plate Heatsink.

RATING AND CHARACTERISTIC CURVES

FIG.1-TYPICAL FORWARD CURRENT DERATING CURVE

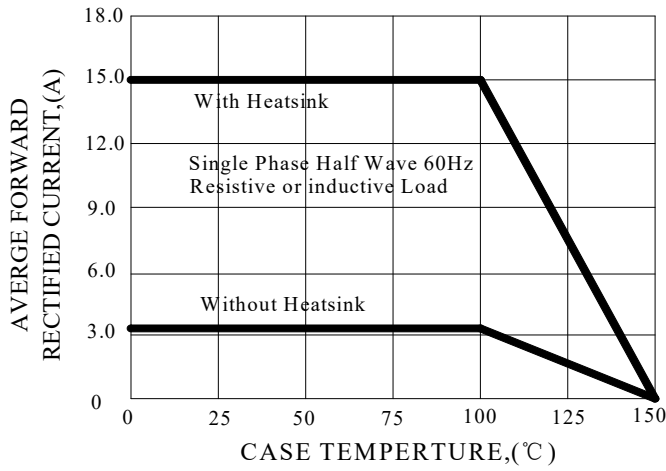

FIG.2-TYPICAL INSTANTANEOUS FORWARD CHARACTERISTICS

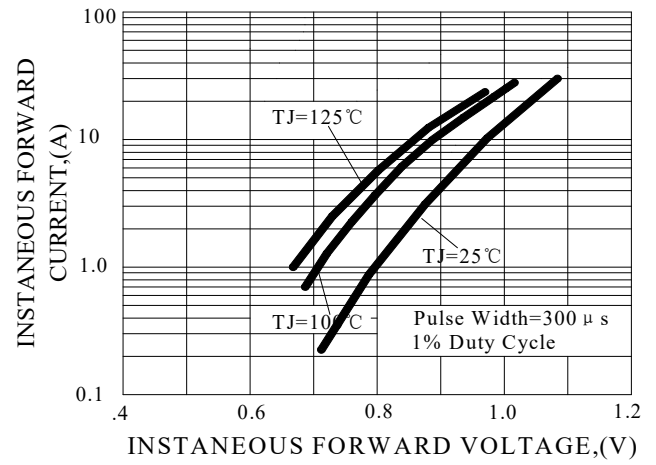

FIG.3-MAXIMUN NON-REPETITIVE FORWARD SURGE CURRENT

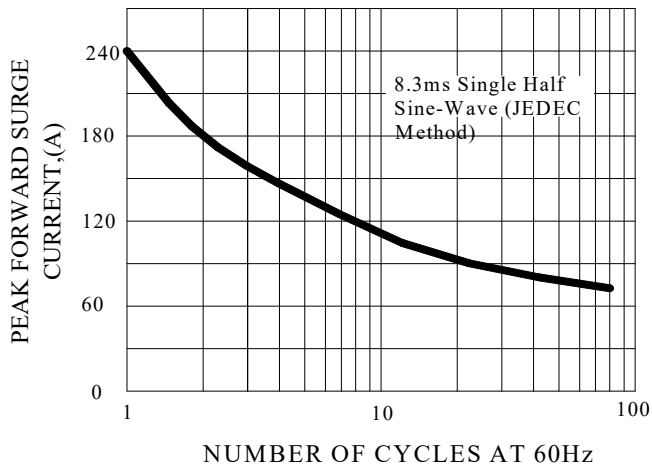

FIG.4-TYPICAL JUNCTION CAPAOTANCE

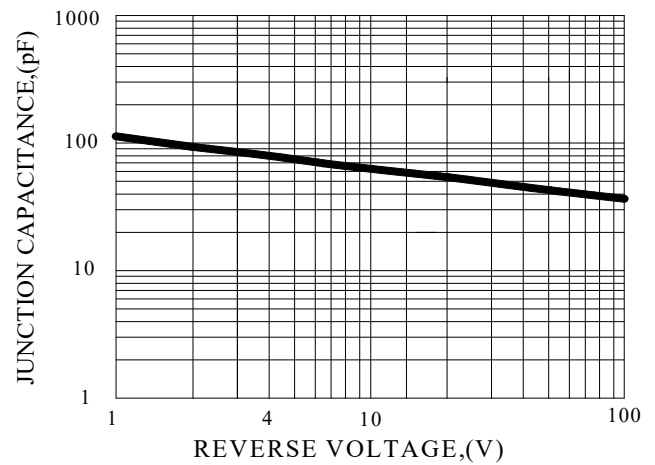
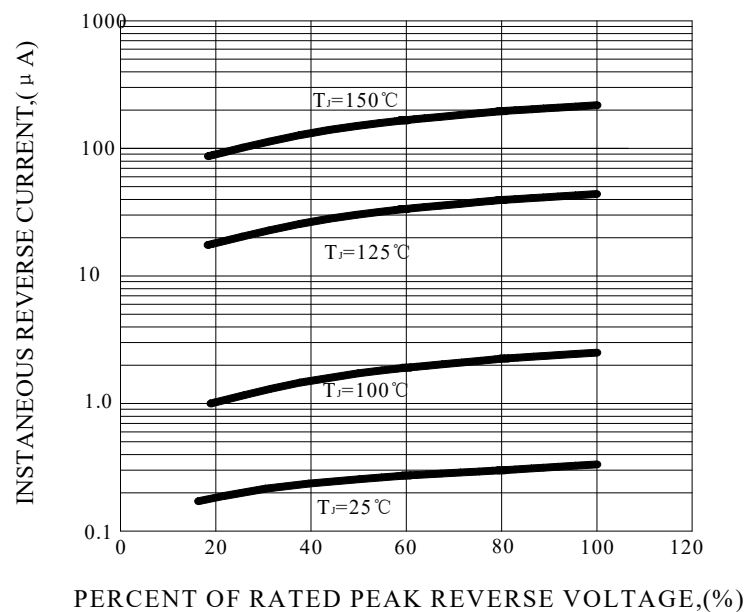
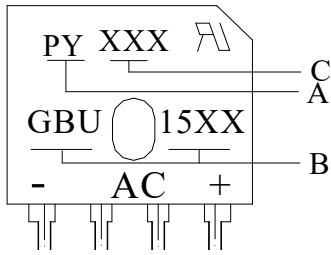

FIG.5-TYPICAL REVERSE CHARACTERISTICS



Marking and packaging illustration

1、Marking



SYMBOL	Explanation
A	Trademark
B	Product Name
C	Date code

2、Packaging

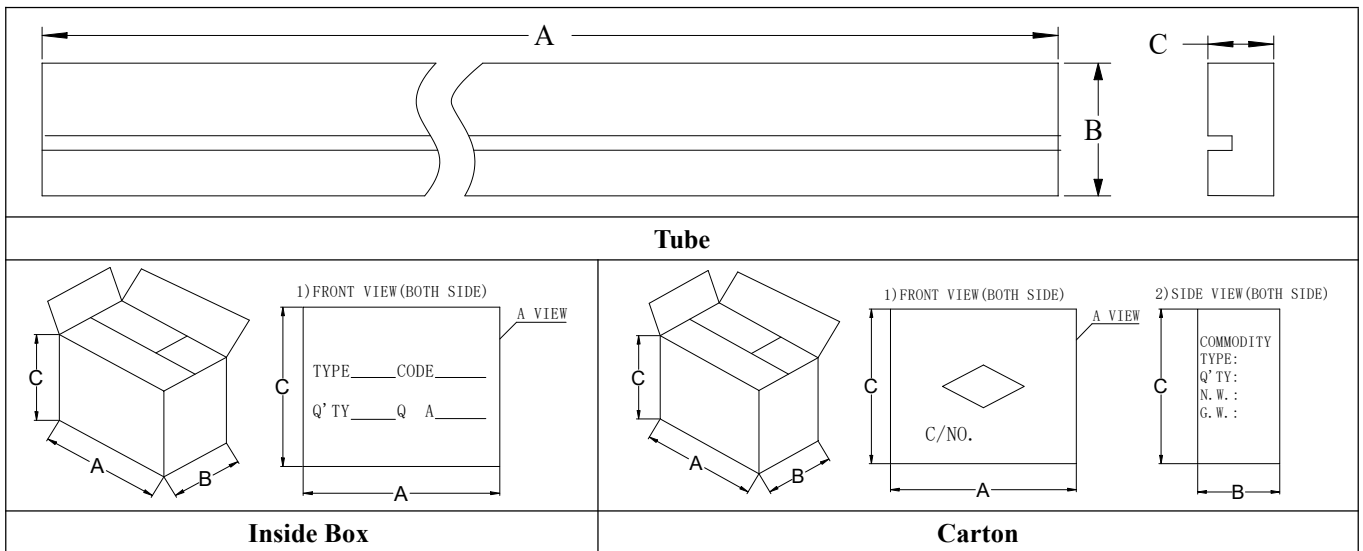

OUTLINE	A (mm)	B (mm)	C (mm)
Tube	470±1	41±1	7.0±1
Inner box	485±3	130±3	130±3
Carton	500±5	285±5	150±5
COUNT	TUBE (PCS)	BOX (PCS)	CARTON (PCS)
GBU	20	1000	2000