

**DSS36**

**3.0AMPS. SURFACE MOUNT SCHOTTKY BARRIER RECTIFIERS**

**FEATURES**

- For surface mounted application
- High current capability
- Low forward voltage drop
- Low power loss, high efficiency
- High surge current capability
- High temperature soldering guaranteed:  
250°C/10 seconds at terminals.

**MECHANICAL DATA**

- Case: JEDEC SOD-123FL,molded plastic over passivated chip
- Terminals:Solder Plated, solder able per MIL-STD-750, Method 2026
- Polarity: Color band denotes cathode end
- Weight: 0.006 ounces, 0.02 gram
- Mounting position: Any

**SOD-123FL**

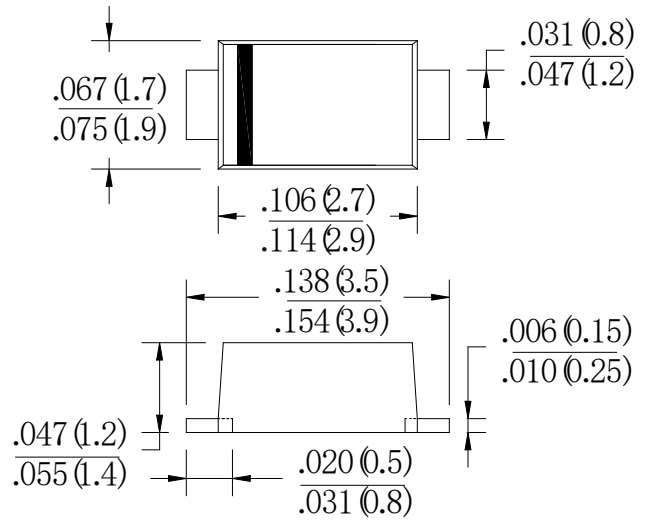

Dimensions in millimeters

**MAXIMUM RATINGS AND ELECTRICAL CHARACTERISTICS**

Ratings at 25°C ambient temperature unless otherwise specified.  
Single phase, half wave, 60Hz,resistive or inductive load. For capacitive load, derate current by 20%.

Type Number	SYM BOL	DSS36	units
	marking	D36	
Maximum Recurrent Peak Reverse Voltage	$V_{RRM}$	60	V
Maximum RMS Voltage	$V_{RMS}$	42	V
Maximum DC Blocking Voltage	$V_{DC}$	60	V
Maximum Average Forward rectified Current	$I_{F(AV)}$	3.0	A
Peak Forward Surge Current 8.3ms single half sine-wave superimposed on rate load (JEDEC method)	$I_{FSM}$	80.0	A
Maximum forward Voltage at 3.0 A DC	$V_F$	0.7	V
Maximum DC Reverse Current @ $T_J=25^{\circ}C$ at rated DC blocking voltage @ $T_J=100^{\circ}C$	$I_R$	0.2	mA
		10.0	
Typical Junction Capacitance (Note 1)	$C_J$	150	pF
Typical thermal resistance (Note 2)	$R_{(JA)}$	180	$^{\circ}C/W$
	$R_{(JC)}$	35	
Storage Temperature Range	$T_{STG}$	-55 to +150	$^{\circ}C$
Operation Temperature Range	$T_J$	-55 to +150	$^{\circ}C$

**Note:**

1. Measured at 1MHz and applied reverse voltage of 4.0 volts d.c.
2. Measured on P.C.Board with 0.2×0.2”(5.0×5.0mm)Copper Pad Areas

**RATING AND CHARACTERISTIC CURVES**

FIG.1-TYPICAL FORWARD CURRENT DERATING CURVE

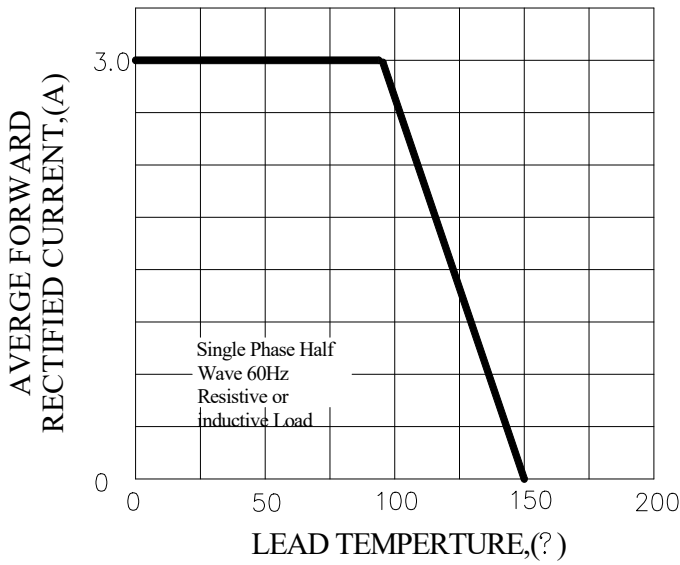

FIG.2-TYPICAL INSTANTANEOUS FORWARD CHARACTERISTICS

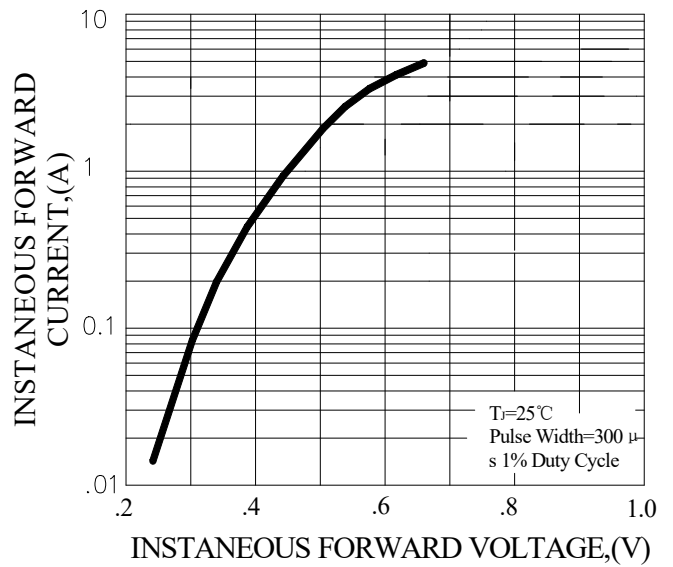

FIG.3-MAXIMUM NON-REPETITIVE FORWARD SURGE CURRENT

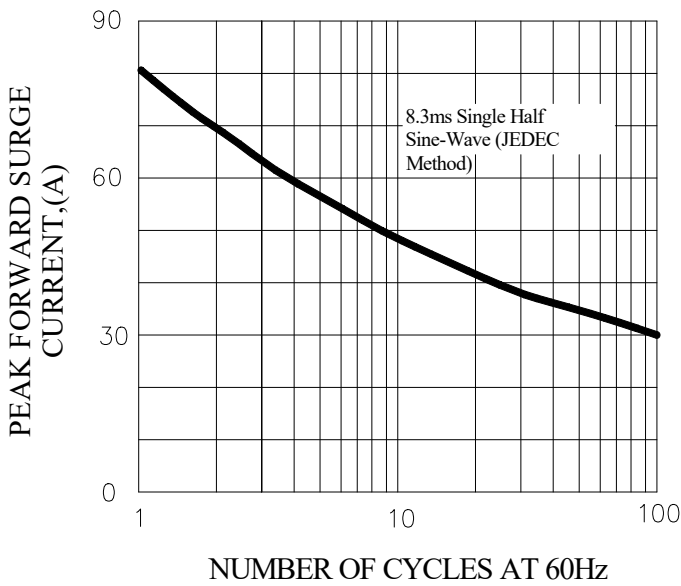
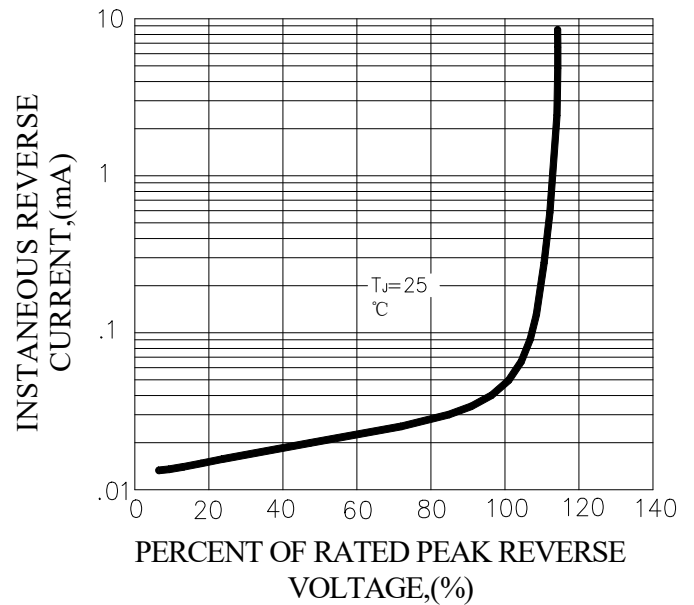
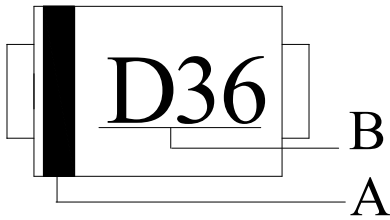

FIG.4-TYPICAL REVERSE CHARACTERISTICS



## Marking and packaging illustration

### 1、Marking



SYMBOL	Explanation
A	Color Band Denotes Cathode
B	Product Name

### 2、Packaging

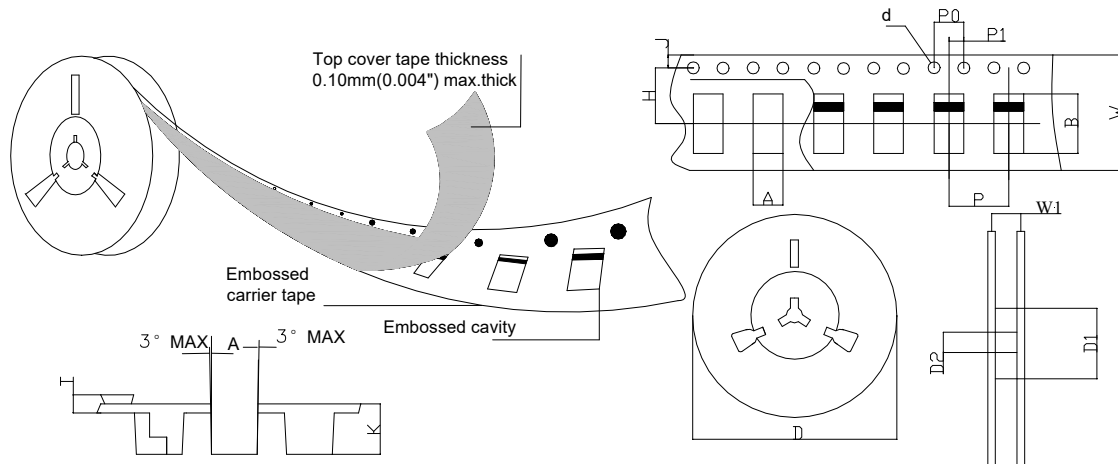

SPECIFICATIONS mm(inch)		PACKAGE	SPECIFICATIONS mm(inch)		PACKAGE
ITEM	SYM BOL	SOD-123FL	ITEM	SYM BOL	SOD-123FL
Carrier width	A	2.1(0.083)Max	Carrier depth	K	1.60(0.063)Typ
Carrier length	B	4.0(0.157)Max	Punch hole pitch	P	4.00(0.157)Typ
Sprocket hole	d	ø1.55(0.061)Typ	Sprocket hole pitch	P0	4.00(0.157)Typ
Reel outer diameter	D	177.8(7)Typ	Embossment center	P1	2.00(0.079)Typ
Reel inner diameter	D1	50.0(1.969)Min	Overall tape thickness	T	0.25(0.098)Typ
Feed hole diameter	D2	13.0(0.512)Typ	Tape width	W	8.15(0.321)Typ
Sprocket hole position	J	1.75(0.069)Typ	Reel width	W1	10.5(0.413)Min
Punch hole position	H	3.50(0.138)Typ			