

## MBR20100CT&MBR20100FCT

### 20.0AMPS. SCHOTTKY BARRIER RECTIFIERS

#### FEATURE

- . High current capability
- . Low forward voltage drop
- . Low power loss, high efficiency
- . High surge capability
- . High temperature soldering guaranteed  
260°C /10seconds, 0.25"(6.35mm)from case.

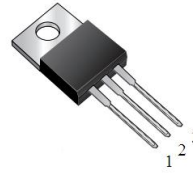

TO-220AB-3L  
MBR20100CT

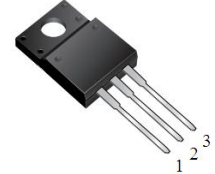

TO-220F-3L  
MBR20100FCT

#### MECHANICAL DATA

- . Case: Molded with UL-94 Class V-0 recognized  
Flame Retardant Epoxy
- . Mounting position: any

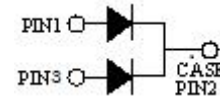

Single phase, half wave, 60Hz, resistive or inductive load.

For capacitive load, derate current by 20%

#### MAXIMUM RATINGS (T<sub>C</sub>=25°C unless otherwise noted)

| Parameter   | Symbol  | MBR20100CT&MBR20100FCT | Units |
|---|---|------------------------|-------|
| Maximum Recurrent Peak Reverse Voltage  | V <sub>RRM</sub>  | 105                    | V     |
| Maximum DC blocking Voltage   | V <sub>DC</sub>   | 105                    | V     |
| Maximum Average Forward Rectified Current<br>at T <sub>C</sub> =100°C                               | <i>I<sub>F(AV)</sub></i><br><i>Per Leg</i><br><i>Total device</i> | 10.0<br>20.0           | A     |
| Peak Forward Surge Current 8.3ms single half sine-wave<br>superimposed on rated load (JEDEC method) | <i>I<sub>FSM</sub></i><br><i>Per Leg</i>                          | 150.0                  | A     |
| Typical Junction Capacitance (Note 1)   | C <sub>J</sub>  | 235                    | pF    |
| Operation Junction Temperature and Storage Temperature  | T <sub>J</sub> , T <sub>STG</sub>                                 | -55 to +150            | °C    |

#### ELECTRICAL CHARACTERISTICS - (Per Leg) (T<sub>C</sub>=25°C unless otherwise noted)

| Parameter               | Symbol         | Test conditions       | Typ                  | Max  | Units |    |
|-------------------------|----------------|-----------------------|----------------------|------|-------|----|
| Forward voltage drop    | V <sub>F</sub> | T <sub>J</sub> =25°C  | I <sub>F</sub> =2A   | 0.55 | ---   | V  |
|                         |                |                       | I <sub>F</sub> =5A   | 0.67 | ---   |    |
|                         |                |                       | I <sub>F</sub> =10A  | 0.76 | 0.85  |    |
|                         |                | T <sub>J</sub> =125°C | I <sub>F</sub> =2A   | 0.44 | ---   |    |
|                         |                |                       | I <sub>F</sub> =5A   | 0.53 | ---   |    |
|                         |                |                       | I <sub>F</sub> =10A  | 0.61 | 0.70  |    |
| Reverse leakage current | I <sub>R</sub> | T <sub>J</sub> =25°C  | V <sub>R</sub> =100V | ---  | 0.01  | mA |
|                         |                | T <sub>J</sub> =125°C | V <sub>R</sub> =100V | ---  | 10    |    |

#### THERMAL CHARACTERISTICS(T<sub>C</sub>=25°C unless otherwise noted)

| Parameter                           | Symbol            | MBR20100CT | MBR20100FCT | Units |
|-------------------------------------|-------------------|------------|-------------|-------|
| Typical Thermal Resistance (Note 2) | R <sub>(JC)</sub> | 2.0        | 3.0         | °C/W  |

#### Notes:

1. Measured at 1.0 MHz and applied reverse voltage of 4.0Vdc
2. Thermal Resistance from Junction to Case

RATING AND CHARACTERISTIC CURVES

FIG.1-TYPICAL FORWARD CURRENT DERATING CURVE

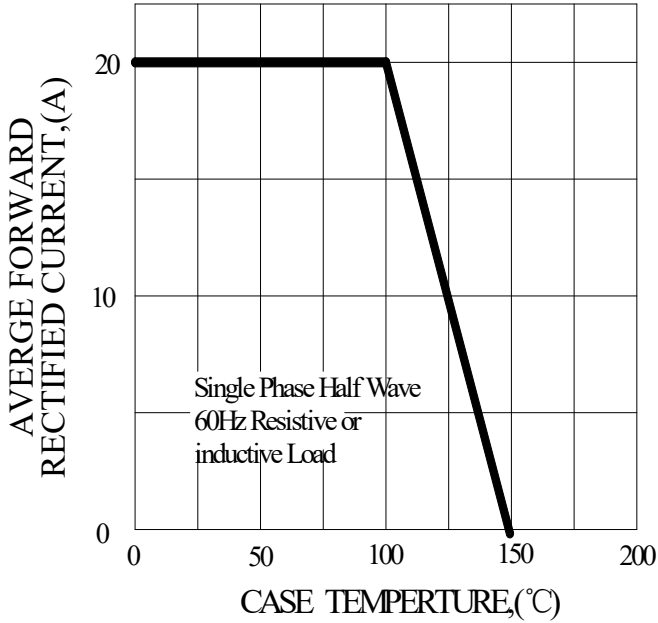

FIG.2-TYPICAL INSTANTANEOUS FORWARD CHARACTERISTICS

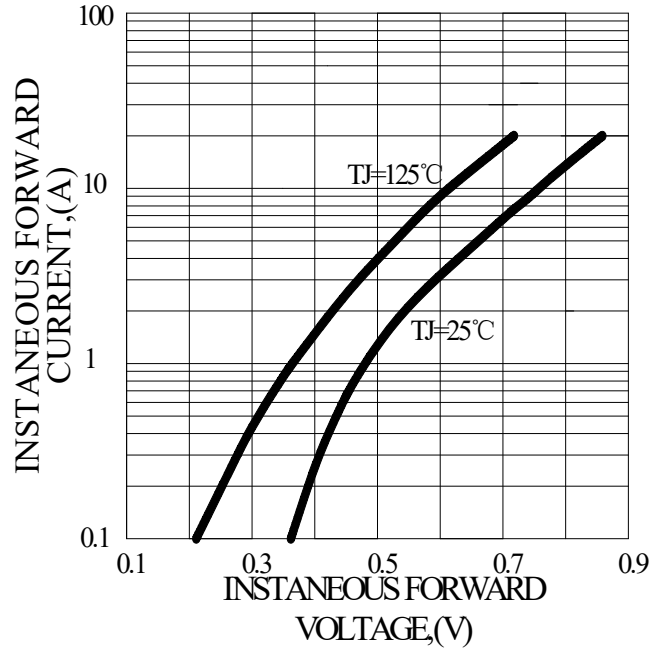

FIG.3-MAXIMUM NON-REPETITIVE FORWARD SURGE CURRENT

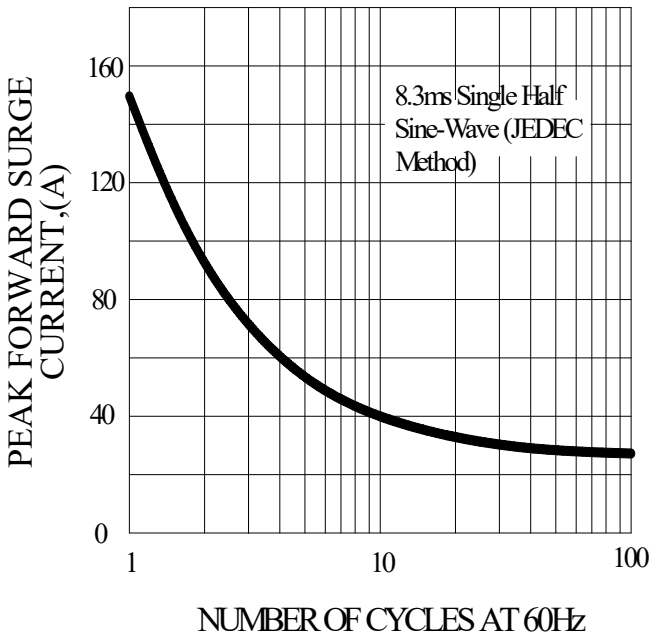
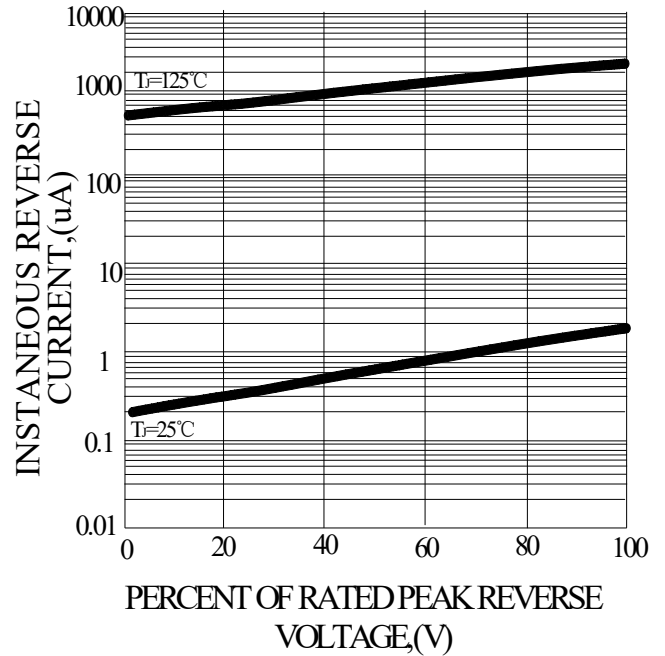
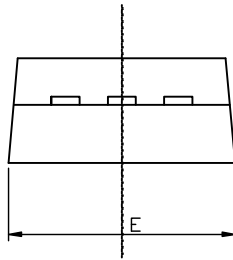
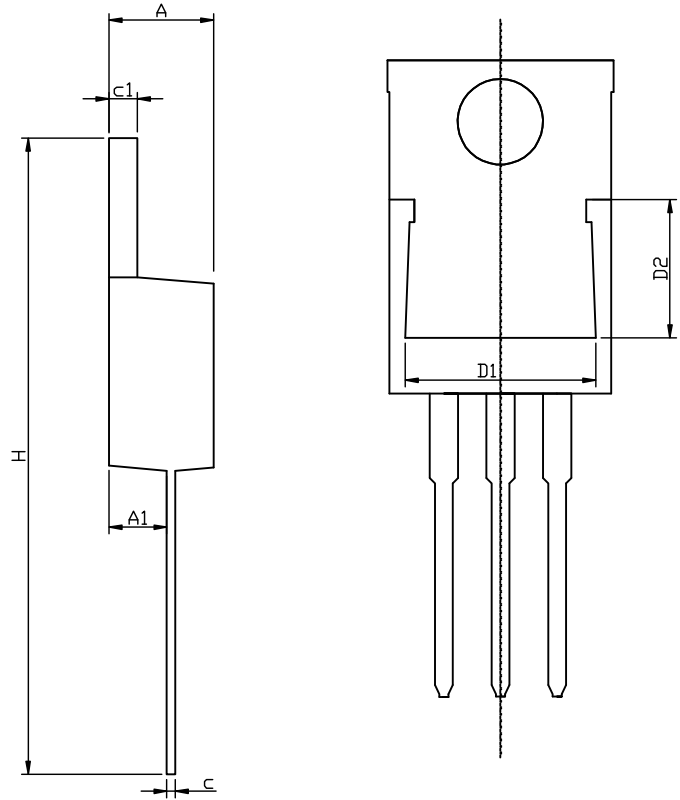
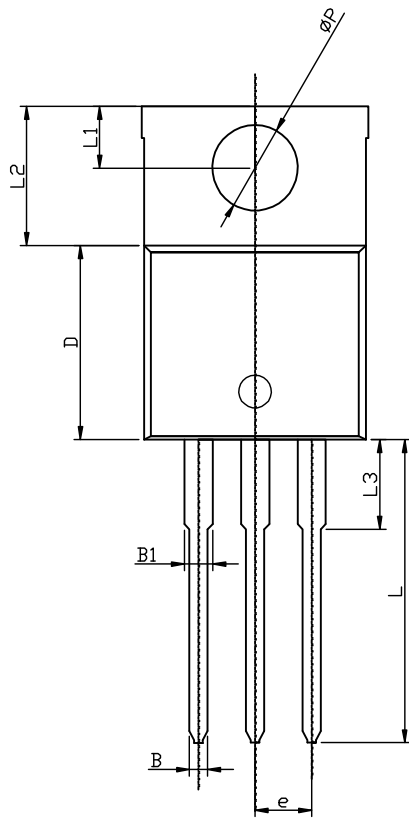

FIG.4-TYPICAL REVERSE CHARACTERISTICS



# TO-220AB-3L PACKAGE OUTLINE



RECOMMENDED LAND PATTERN

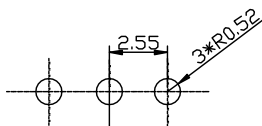

UNIT: mm

|    | MIN   | NOM   | MAX   |
|----|-------|-------|-------|
| A  | 4.50  | 4.70  | 4.90  |
| A1 | 2.45  | 2.60  | 2.70  |
| B  | 0.72  | 0.82  | 0.92  |
| B1 | 1.12  | 1.27  | 1.42  |
| c  | 0.28  | 0.38  | 0.48  |
| c1 | 1.17  | 1.27  | 1.37  |
| D  | 8.46  | 8.66  | 8.86  |
| D1 | 7.90  | 8.10  | 8.40  |
| D2 | 5.50  | 5.70  | 5.90  |
| e  | 2.45  | 2.55  | 2.65  |
| E  | 9.85  | 10.15 | 10.45 |
| H  | 28.00 | 28.50 | 29.00 |
| ΦP |       | 3.84  |       |
| L  | 13.1  | 13.6  | 14.1  |
| L1 | 2.54  | 2.74  | 2.94  |
| L2 | 6.04  | 6.24  | 6.44  |
| L3 | 3.85  | 4.05  | 4.35  |

# TO-220F-3L PACKAGE OUTLINE

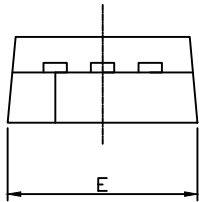
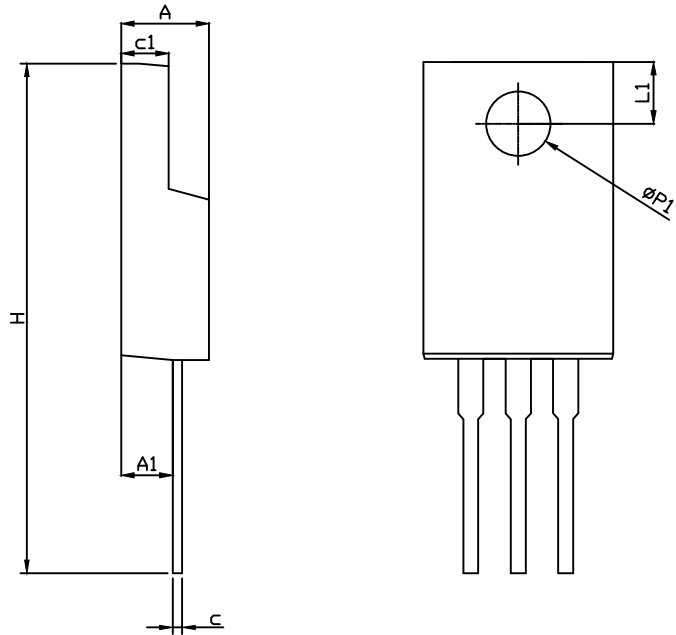
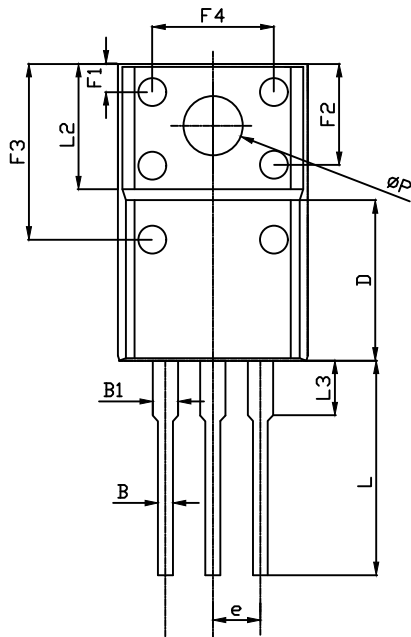

RECOMMENDED LAND PATTERN

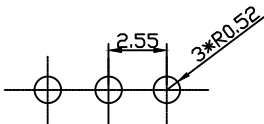

UNIT: mm

|           | MIN   | NOM     | MAX   |
|-----------|-------|---------|-------|
| A         | 4.40  | 4.60    | 4.80  |
| A1        | 2.63  | 2.76    | 2.89  |
| B         | 0.75  | 0.80    | 0.90  |
| B1        | 1.12  | 1.27    | 1.42  |
| c         | 0.40  | 0.50    | 0.60  |
| c1        | 2.60  | 2.70    | 2.80  |
| D         | 7.50  | 7.80    | 8.10  |
| e         | -     | 2.55REF | -     |
| E         | 9.86  | 10.00   | 10.10 |
| F1        | 1.90  | 2.12    | 2.40  |
| F2        | 5.00  | 5.30    | 5.65  |
| F3        | 8.70  | 9.00    | 9.30  |
| F4        | 6.20  | 6.50    | 6.80  |
| H         | 27.80 | 28.30   | 28.80 |
| L         | 13.10 | 13.30   | 13.50 |
| L1        | 2.85  | 3.00    | 3.15  |
| L2        | -     | 6.70REF | -     |
| L3        | 3.10  | 3.60    | 4.10  |
| $\Phi P$  | 3.00  | 3.30    | 3.60  |
| $\Phi P1$ | 2.80  | 3.10    | 3.40  |