

**GBL306 THRU GBL310**

**SINGLE PHASE 3.0AMPS.GLASS PASSIVATED BRIDGE RECTIFIERS**

**FEATURE**

- . UL Listed Under Recognized Component Index, File Number E338195
- . Glass passivated chip junctions
- . High case dielectric strength
- . Low Reverse Leakage Current
- . High surge current capability
- . Ideal for Printed Circuit Board Applications

**MECHANICAL DATA**

- . Case Material: Molded Plastic.
- . UL Flammability Classification Rating 94V-0
- . Terminals: Pure tin plated, Lead free.
- . Leads solderable per MIL-STD-750, Method 2026.
- . Polarity: Marked on body
- . Mounting position: Any

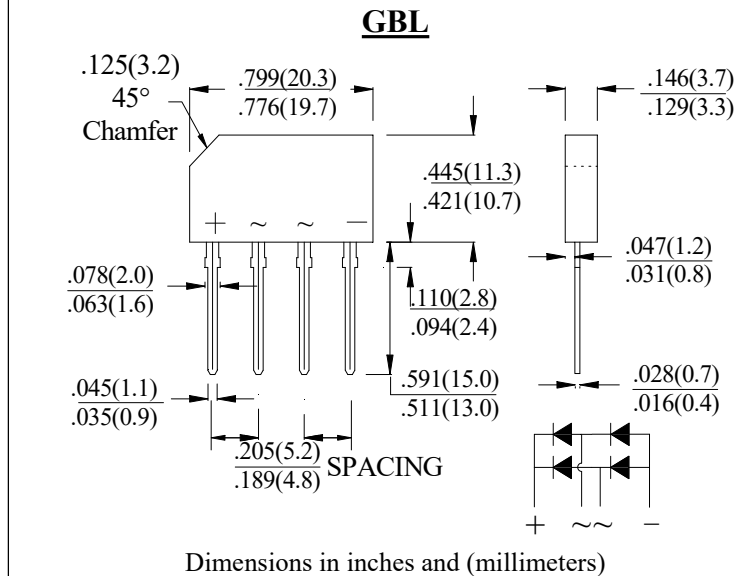

**MAXIMUM RATINGS AND ELECTRICAL CHARACTERISTICS**

Ratings at 25°C ambient temperature unless otherwise specified.

Single phase, half wave, 60Hz, resistive or inductive load. For capacitive load, derate current by 20%

Type Number	SYM BOL	GBL306	GBL308	GBL310	units
Maximum Recurrent Peak Reverse Voltage	$V_{RRM}$	600	800	1000	V
Maximum RMS Voltage	$V_{RMS}$	420	560	700	V
Maximum DC blocking Voltage	$V_{DC}$	600	800	1000	V
Maximum Average Forward (with heatsink Note2) Rectified Current @ $T_C=100^{\circ}C$ (without heatsink)	$I_{F(AV)}$		3.0 1.5		A
Peak Forward Surge Current 8.3ms single half sine-wave superimposed on rate load (JEDEC method)	$I_{FSM}$		90		A
Maximum Forward Voltage @ 3.0A DC Drop per element @ 1.5A DC	$V_F$		1.1 1.0		V
Maximum DC Reverse Current @ $T_J=25^{\circ}C$ at rated DC blocking voltage @ $T_J=125^{\circ}C$	$I_R$		5.0 500.0		$\mu A$
$I^2t$ Rating for Fusing ( $t < 8.3ms$ )	$I^2t$		33.6		$A^2Se$ c
Typical Junction Capacitance (Note 1)	$C_J$		35		pF
Typical Thermal Resistance (Note 2)	$R_{(JC)}$		4.2		$^{\circ}C/W$
Storage Temperature	$T_{STG}$		-55 to +150		$^{\circ}C$
Operating Junction Temperature	$T_J$		-55 to +150		$^{\circ}C$

**Note:**

1. Measured at 1.0 MHz and applied reverse voltage of 4.0Vdc
2. Device mounted on 50mm x 50mm x 1.6mm Cu Plate Heatsink.

**RATING AND CHARACTERISTIC CURVES**

FIG.1-TYPICAL FORWARD CURRENT DERATING CURVE

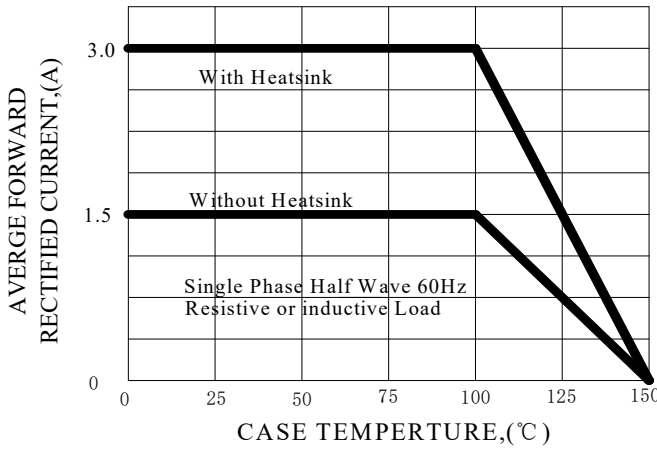

FIG.2-TYPICAL INSTANTANEOUS FORWARD CHARACTERISTICS

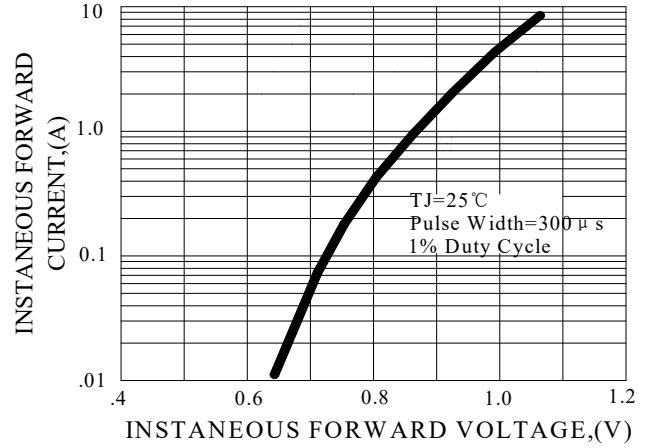

FIG.3-MAXIMUN NON-REPETITIVE FORWARD SURGE CURRENT

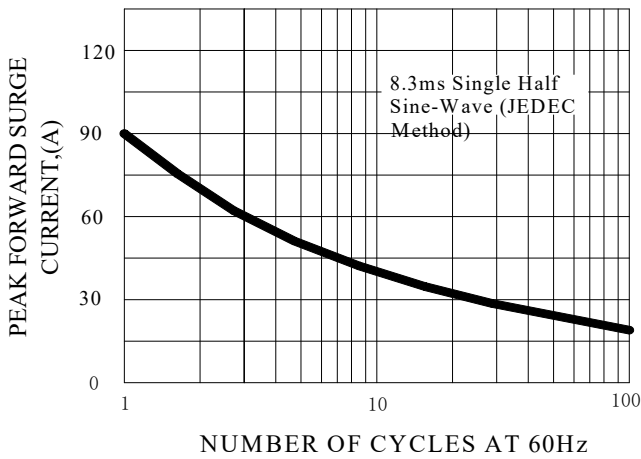

FIG.4-TYPICAL JUNCTION CAPAOTANCE

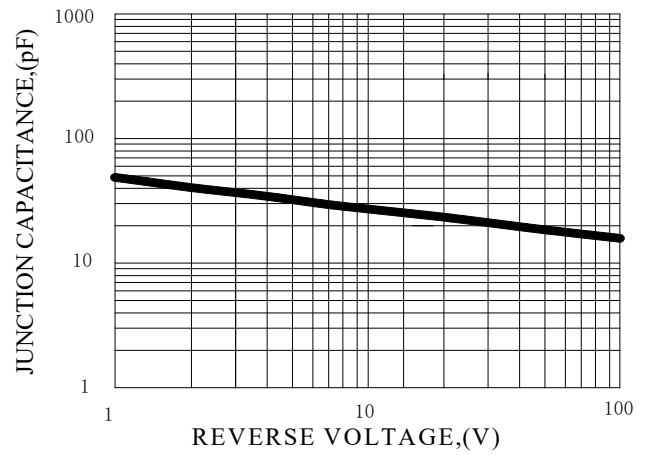
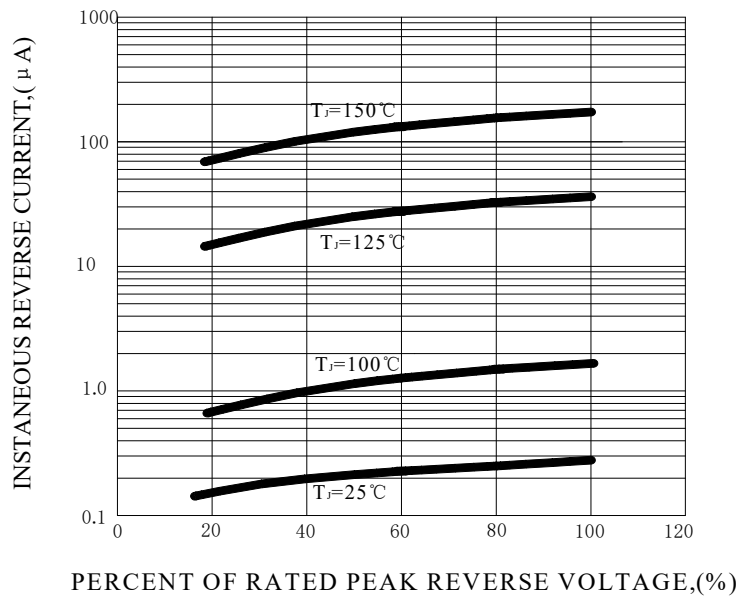
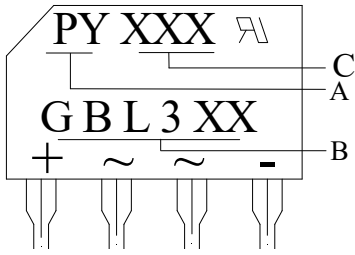

FIG.5-TYPICAL REVERSE CHARACTERISTICS



## Marking and packaging illustration

### 1、Marking



SYMBOL	Explanation
<b>A</b>	Trademark
<b>B</b>	Product Name
<b>C</b>	Date code

### 2、Packaging

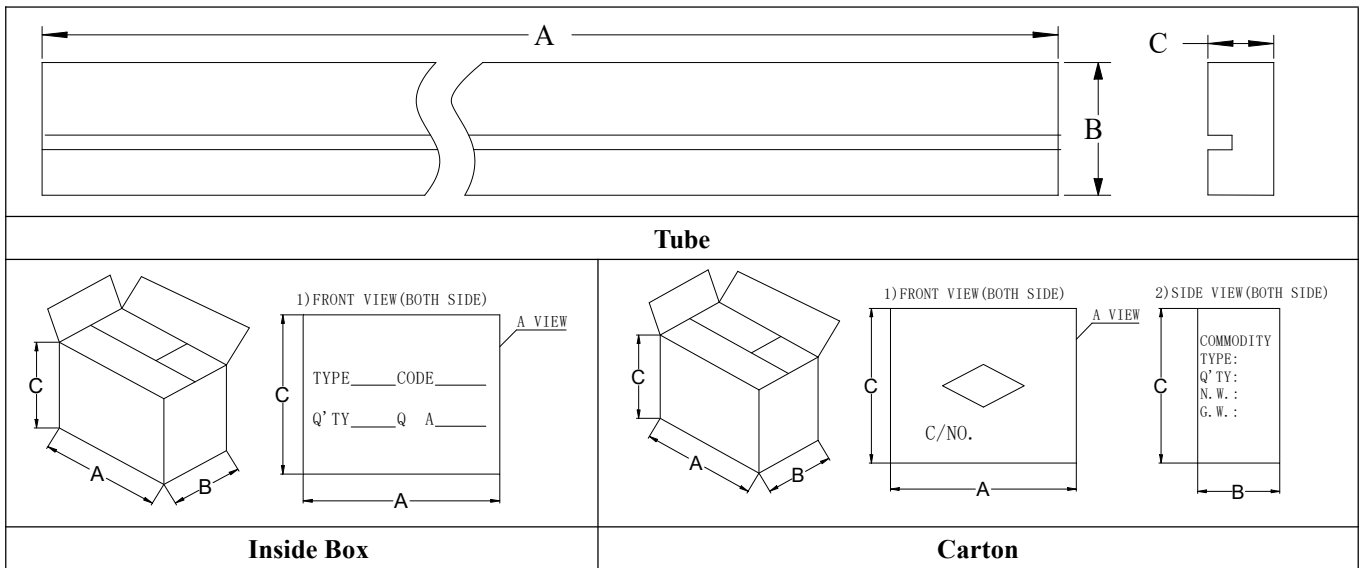

OUTLINE	A (mm)	B (mm)	C (mm)
Tube	512.5±1	28.8±1	6.1±1
Inner box	528±3	138±3	128±3
Carton	548±5	290±5	148±5
COUNT	TUBE (PCS)	BOX (PCS)	CARTON (PCS)
GBL	25	2000	4000